



TROUBLESHOOTING GUIDE

Having trouble with the sound system?

Condition

No sound (power LED not lit):

- #### Possible Solution
- turn POWER switch on
 - plug in power cord

No sound (power LED lights):

- check for output from source
- make sure all cables are completely plugged in
- increase volume control
- press mute button on remote (AN-130RC only)
- turn power switch to off then back to on (AN-130RC only)

Distorted sound:

- check input cable connection
- lower input signal level

Excessive hum or noise:

- use shielded input cable

Having trouble with the wireless system?

Condition

No sound:

- #### Possible Solution
- confirm transmitter power switch is set to on
 - turn up volume control
 - plug microphone into body-pack transmitter
 - turn sound system on
 - replace mic/transmitter battery
 - make sure collar, headband or lapel mic cable is fully plugged into transmitter
 - turn off mute by pressing, volume up, volume down or mute (AN-130RC only)

Frequent transmitter dropouts:

- replace mic/transmitter battery
- move mic/transmitter closer to AN-130
- change transmitter to different channel

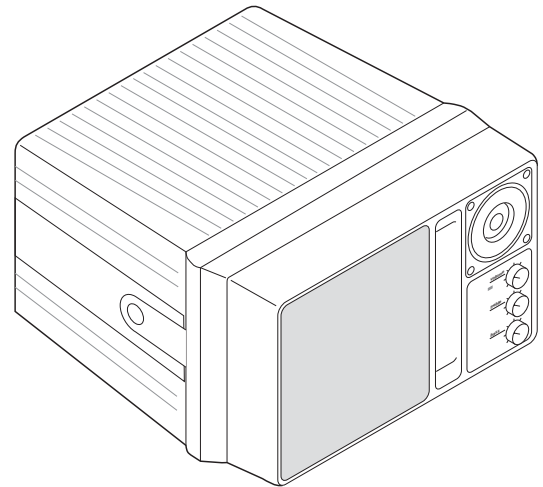

AN-130
AN-130DC
AN-130RC
AN-130U1

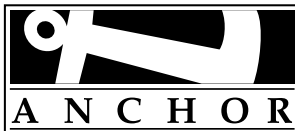

ANCHOR Audio, Inc. (310) 784-2300
100-0126-000 / Rev. A - 08/03

Owner's Manual





IMPORTANT SAFEGUARDS



CAUTION: To reduce the risk of electric shock, do not remove the cover. No user-serviceable parts inside. Refer servicing to qualified personnel.

WARNING: To prevent fire or electric shock, do not expose this equipment to rain or moisture.

CAUTION: To reduce the risk of fire, replace only with same type fuse (see specifications).



ATTENTION: Pour éviter les risques de choc électrique, ne pas enlever le couvercle. Aucun entretien de pièces intérieures par l'utilisateur. Confier l'entretien au personnel qualifié.

AVIS: Pour éviter les risques d'incendie ou d'électrocution, n'exposez pas cet article à la pluie ou à l'humidité.

ATTENTION: Pour diminuer le risque d'incendie, remplacer par des fusibles de même type (voir caractéristiques).

EXPLANATION OF GRAPHICAL SYMBOLS



The lightning flash with arrowhead symbol, within an equilateral triangle, is intended to alert the user to the presence of uninsulated "dangerous voltage" within the product's enclosure that may be of sufficient magnitude to constitute a risk of electric shock to humans.



The exclamation point, within an equilateral triangle, is intended to alert the user to the presence of important operating and maintenance (servicing) instructions in the literature accompanying the appliance.

EXPLICATION DES SYMBOLES GRAPHIQUES



Le symbole éclair avec point de flèche à l'intérieur d'un triangle équilatéral est utilisé pour alerter l'utilisateur de la présence à l'intérieur du coffret de "voltage dangereux" non isolé d'ampleur suffisante pour constituer un risque d'électrocution.



Le point d'exclamation à l'intérieur d'un triangle équilatéral est employé pour alerter les utilisateurs de la présence d'instructions importantes pour la fonctionnement et l'entretien (service) dans le livret d'instruction accompagnant l'appareil.

DATE OF MANUFACTURE

The date of manufacture of this Anchor Audio product can be determined by the eight digit serial number code. The fourth digit denotes the year, the third digit (letter) denotes the month (A=Jan, B=Feb, etc.) Example: "AWD01432" states that the unit was manufactured in April of 2000.

SPECIFICATIONS

Rated power output:	30 watts
Sensitivity for rated output:	
Line:	-20 dBV (100 mVrms)
Microphone:	-43 dBV (7.5 mVrms)
Instrument:	-30 dBV (30 mVrms)
Frequency response:	65 Hz – 18 kHz ± 3dB
Max SPL @ rated power:	101 dB @ 1 meter
Speaker type:	4.5 inch woofer, 10mm dome tweeter
Inputs	
Line inputs (2):	Hi-Z, unbalanced, RCA (summing L+R)
Microphone input:	Lo-Z, unbalanced, 1/4"-phone
Instrument input:	(3k), unbalanced, 1/4"-phone
DC output:	12 Volts DC, 100 mA max
RF Wireless Receiver:	PLL Synthesized
Sensitivity:	2µV at S/N 40 dB
Frequency:	682.375 MHz - 697.125 MHz
AC Power requirements	110 - 125 VAC, 50/60 Hz
export model:	208 - 240 VAC, 50/60 Hz (50 watts max)
Fuse rating:	T 1.0A / 250V
export model:	T 0.5A / 250V (internally mounted)
Dimensions (HWD):	5.25 x 8.4 x 9", 13 x 21 x 23 cm
Weight:	8.5 lbs, 3.8 Kg

Specifications subject to change without notice.



NOTES

Thank you for choosing an Anchor Audio portable sound system. Our products incorporate state-of-the-art design and the finest quality of materials and workmanship. We're proud of our products and appreciate the confidence which you have shown by selecting an Anchor system.

I hope you'll take a few of minutes to review this manual. We've incorporated several unique features into our products, and your knowledge of how to use them will enhance the performance and your enjoyment of the system.

*David Jacobs, President
on behalf of all Anchor Employees*

CONTENTS

Quick Use Guide	2
Feedback Information	2
Getting Started	3
General Operation	4-5
Wireless Operation	6-8
Wireless Remote Control	9
Accessories	10-11
Specifications	13
Troubleshooting Guide	back cover



QUICK USE GUIDE

The AN-130 monitor is used to amplify the signal from a microphone, electronic musical instrument or line-level sources (cassette, CD, VCR, etc). You'll need a connection cable and an AC outlet.

Here's How Easy It Is To Use:

1. Place the AN-130 at desired location.
2. Set volume control on front of speaker to minimum before turning on the power.
3. Plug the power cord into a grounded 115 volt outlet (220 volt outlet for export model).
4. Plug a microphone into the MIC input jack, or an audio source into the INST or LINE 1 / LINE 2 jacks.
5. Turn the power switch on the rear panel "ON" (the red LED on front panel should light).
6. Adjust the volume, bass and treble controls for desired sound.

For general operating instructions, see the "General Operation" section beginning on page 4.

Operating instructions for the wireless mic system on model AN-130U1 are under "Wireless Operation" on pages 6 to 8.

Operating instructions for the AN-130RC remote control are under "Wireless Remote Control" on page 9.

FEEDBACK INFORMATION

What Causes Feedback?

Feedback is a ringing, howling, or shrill sound that is self-generated by the sound system. It is the result of sound from the speakers being picked up by the microphone(s) in use and then re-amplified by the system. This can form a self-sustaining loop that can damage the sound system if allowed to continue.

How To Prevent Feedback

Always stand behind the speaker when using a microphone.

To avoid feedback, always make sure volume controls are at minimum before turning unit on. If feedback occurs, immediately reduce the volume.

ACCESSORIES

REMOTE-130 Wireless Remote Control

Controls volume up, down and mute for the AN-130RC.

MIC-90P Handheld Microphone

Professional dynamic, cardioid pattern handheld mic. Comes with a 20' cable with 1/4"-phone plug and mic clip.

WH-6000

UHF wireless handheld microphone/transmitter.

WB-6000

UHF wireless body-pack transmitter (order mic separately).

CM-60

CollarMic microphone for use with WB-6000, UHF wireless body-pack transmitter.

HBM-60

Headband microphone for use with WB-6000, UHF wireless body-pack transmitter.

LM-6000

Lapel microphone for use with WB-6000, UHF wireless body-pack transmitter.

NOTE:
Problems?
Consult the
troubleshooting
section on the
back page of
this manual.

CAUTION:
Feedback can
damage your
equipment
and may be
hazardous to
your hearing.



ACCESSORIES

SS-250 Speaker Stand

Adjustable stand made of black, anodized aluminum.

MSB-201 Combination Mic/Speaker Stand

Floor stand with 33" adjustable boom. Doubles as speaker stand when combined with SB-1 mounting bracket

HS-1 Carry Handle

Convenient attachable handle for AN-130.

CC-100 Carry Bag

Cordura nylon bag with storage compartment for AN-130.

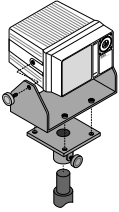

HC-1550 Hard Case

Traveling hard case - holds up to two AN-130's and two mics.

HC-1610B Hard Case

Projector Protector hard case - holds projector, AN-130 and mic.

SB-1

SB-1 Swivel Stand Mounting Bracket

The SB-1 bracket can be used to mount the AN-130 to a wall, ceiling or on a speaker stand (stand adapter included).

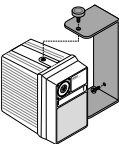

SB-3

SB-3 Swivel Wall Mounting Bracket

Used for mounting the AN-130 to the wall or ceiling.

SB-360 Swivel (360°) Wall Mounting Bracket

Used for mounting the AN-130 to the wall or ceiling.

RM-1 Single Rackmount Kit

RM-12 Dual Rackmount Kit

Rackmount kits allow mounting of AN-130 monitors in a standard equipment rack, three spaces high (5-1/4"). The rackmount kits are adjustable (front/back), and include mounting hardware.

Color: satin black.

GETTING STARTED

System Inspection & Inventory

Check unit carefully for damage which may have occurred during transit. Each Anchor product is carefully inspected at the factory and packed in a special carton for safe transport.

Inventory

NOTE:
All damage claims must be made with the freight carrier.

- AN-130 powered monitor
- Warranty registration card

All damage claims must be made with the freight carrier. Notify the freight carrier immediately if you observe any damage to the shipping carton or product. Repack the unit in the carton and await inspection by the carrier's claim agent. Notify your dealer of the pending freight claim.

IMPORTANT:
Save the shipping carton and packing materials. They were specially designed to ship your unit safely.

Returning Systems For Service or Repair

Should your unit require service, contact your dealer or the Anchor Audio Customer Service Department at (800) 262-4671 to obtain a Return Authorization (RA) number. All shipments to Anchor Audio must include an RA number and must be shipped prepaid. C.O.D. shipments will be refused and returned at your cost.

Warranty Registration

Please fill out the warranty card and return it with a copy of your invoice to Anchor's Customer Service Department. This will activate your limited six year warranty.



GENERAL OPERATION

Operating The Sound System

NOTE:
If no sound can be heard after increasing the volume of your AN-130RC, lower the volume, turn the power switch off then back on. Next slowly increase the volume to the desired level.

1. Place the AN-130 at desired location.
2. Set volume control on front of speaker to minimum before turning on the power.
3. Plug the power cord into a grounded 115 volt outlet (220 volt outlet for export model).
4. Plug a microphone into the MIC input jack, or an audio source into the INST or LINE 1 / LINE 2 jacks.
5. Turn the power switch "ON" (the red LED on front panel should light).
6. Adjust the volume, bass and treble controls for desired sound.

AN-130U1 Back Panel

CAUTION:
ALWAYS use shielded audio cables on input connections to prevent interference.

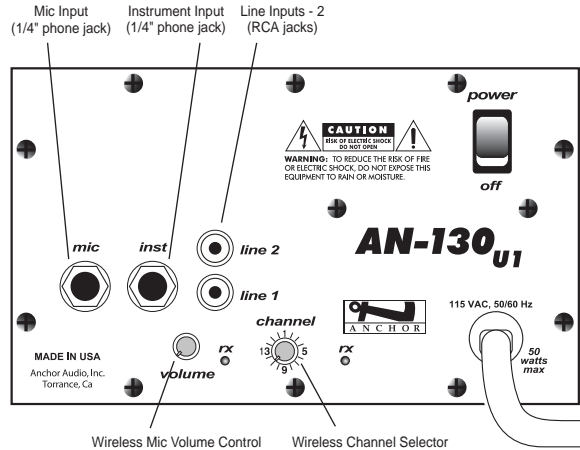

WIRELESS REMOTE CONTROL

Remote Operation (AN-130RC only)

With the red, mute button facing towards the AN-130RC, aim the remote at the red window located near the volume and tone controls. Press the volume up button to increase the volume. Press the volume down button to decrease the volume. To mute the AN-130RC, press the mute button. To un-mute press the mute button again, or press either volume button.

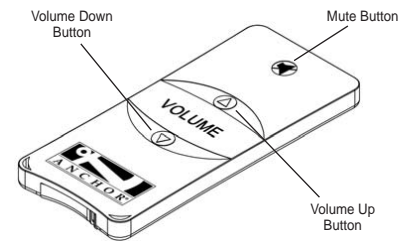

Replacing The Remote Battery

With the bottom of the remote facing up, locate the latch on the bottom of the remote, near the back. Gently pull the latch towards the center of the remote and carefully slide out the battery holder. Place a new battery in the holder so that the positive symbol on the battery is facing up. Carefully re-insert the battery holder. Use only CR2025 or CR2032 type batteries.

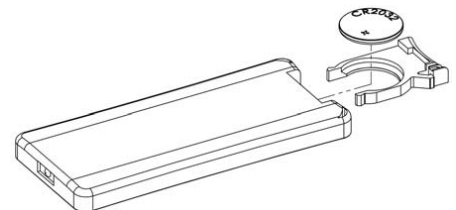



WIRELESS OPERATION

Replacing Transmitter Battery

CAUTION: Harmful feedback may occur when walking in front of a sound system or speaker with a wireless microphone. Always point mic away from speakers.

Handheld Transmitter:

1. Unscrew battery compartment cover on lower end of mic.
2. Install 2 fresh 'AA' alkaline batteries.
3. Replace the battery cover.

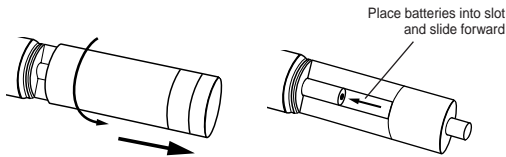

Body-pack Transmitter:

1. Slide open battery cover on front of transmitter box.
2. Install 2 fresh 'AA' alkaline batteries.
3. Close the battery cover.

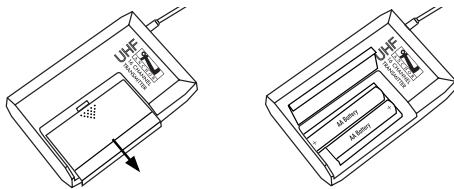

NOTE: Transmitter power switch must be in the OFF position when changing batteries.

GENERAL OPERATION

Line Inputs (summing)

line 2 The line-level RCA input jacks may be used with audio sources such as computers, VCR's, and cassette tape or compact disc players.

line 1 The inputs may be used for two separate sources, or they may be used to sum L+R stereo outputs to a mono signal without the need for adapters.

mic



Mic Input

An unbalanced, low impedance microphone input is for use with the MIC-90P or other mics that have a 1/4" phone plug.

Instrument Input

inst



The instrument input (1/4"-phone jack) is for guitars, keyboards or any instrument with an electronic transducer. It may also be used for wireless microphone receivers. The instrument input has a higher sensitivity than the line input.

Note: All connections must be made with shielded cable to avoid hum, buzzing, or radio interference.

12VDC out



DC Output (AN-130DC model only)

12 Volts DC output jack for use with wireless or other external accessories; maximum capacity of 100 mA max.



WIRELESS OPERATION

Diversity Wireless by Anchor Audio

Anchor Audio UHF wireless is a 16 channel, diversity wireless system that utilizes two independent antennae to receive signal. The diversity feature means that the receiver will process the stronger of the two antenna signals, effectively minimizing dropouts and interference from other transmitting sources. The antennae are mounted internally so there are no obstructions or risk of damage.

Wireless Microphone Operation

- NOTE:** Both the receiver and microphone must be set to the same channel.
- When using more than one wireless unit, make sure each microphone is set to a different channel frequency.
1. If you are using a body-pack transmitter, insert the plug from the mic into the jack marked MIC on the transmitter.
 2. Turn the transmitter power switch to ON. (The red LED will flash when the mic is turned on. If the red LED stays on, the battery is low.)
 3. Turn the AN-130U1 power switch to ON.
 4. The RX indicators will light (one indicator at a time lights) when the wireless signal is being transmitted and received.

WIRELESS OPERATION

Receiver Channel Selection

- NOTE:** Before you use your UHF wireless system, you will need to select a wireless frequency channel. The wireless receiver is mounted inside the AN-130U1 and can be set to any of 16 available channels.
- If you are experiencing ongoing interference with your wireless system, the selected frequency may be incompatible with other RF systems in your area. Try a different channel.
1. Locate the Wireless Channel selector on the back panel.
 2. Using the selector knob set the frequency of the receiver to channel 1 thru 16.



Transmitter Channel Selection

Handheld Transmitter:

1. Unscrew battery cover on lower end of microphone.
2. Set the channel selection dial to match the channel setting on the receiver.
3. Replace the battery cover.

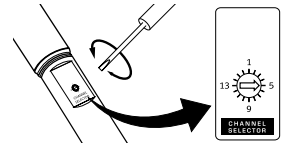

Body-pack Transmitter:

- NOTE:** Be sure that the MIC/LINE switch is in the "MIC" position when a mic is plugged into the TX.
1. The channel selection dial is located on the side of the transmitter.
 2. Set the channel selection dial to match the channel setting on the receiver.

